



Cambridge IGCSE™

CANDIDATE
NAME

--

CENTRE
NUMBER

--	--	--	--	--

CANDIDATE
NUMBER

--	--	--	--



COMBINED SCIENCE

0653/31

Paper 3 Theory (Core)

October/November 2021

1 hour 15 minutes

You must answer on the question paper.

No additional materials are needed.

INSTRUCTIONS

- Answer **all** questions.
- Use a black or dark blue pen. You may use an HB pencil for any diagrams or graphs.
- Write your name, centre number and candidate number in the boxes at the top of the page.
- Write your answer to each question in the space provided.
- Do **not** use an erasable pen or correction fluid.
- Do **not** write on any bar codes.
- You may use a calculator.
- You should show all your working and use appropriate units.

INFORMATION

- The total mark for this paper is 80.
- The number of marks for each question or part question is shown in brackets [].
- The Periodic Table is printed in the question paper.

This document has **24** pages. Any blank pages are indicated.

1 (a) Fig. 1.1 is a diagram of the circulatory system in humans.

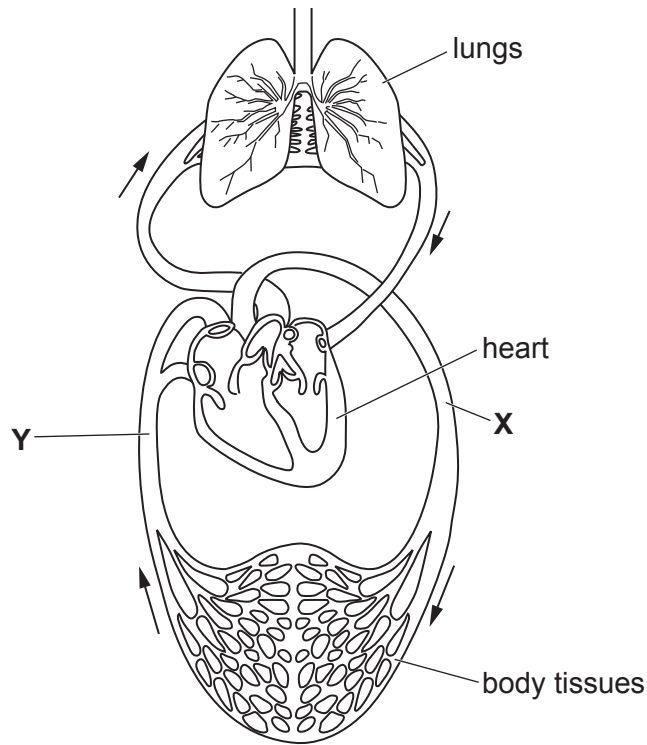

Fig. 1.1

(i) The arrows show the direction of blood flow through the blood vessels.

Blood vessels X and Y are two of the main blood vessels attached to the heart.

Identify blood vessels X and Y shown in Fig. 1.1.

X

Y

[2]

(ii) State the function of the heart.

..... [1]

(iii) Circle the name of the tube that connects the lungs to the nose and mouth.

alveoli bronchi bronchiole larynx trachea

[1]

(b) Complete these sentences about the blood.

Choose words from the list.

Each word may be used once, more than once or not at all.

- chlorophyll glucose haemoglobin nitrogen**
oxygen phagocytosis egestion

There are two types of blood cells, red blood cells and white blood cells.

Red blood cells transport the gas,

The gas binds to a chemical in red blood cells called

White blood cells produce antibodies.

White blood cells are also involved in the process of

[3]

(c) Fig. 1.2 shows the pulse rate of a person doing different activities.

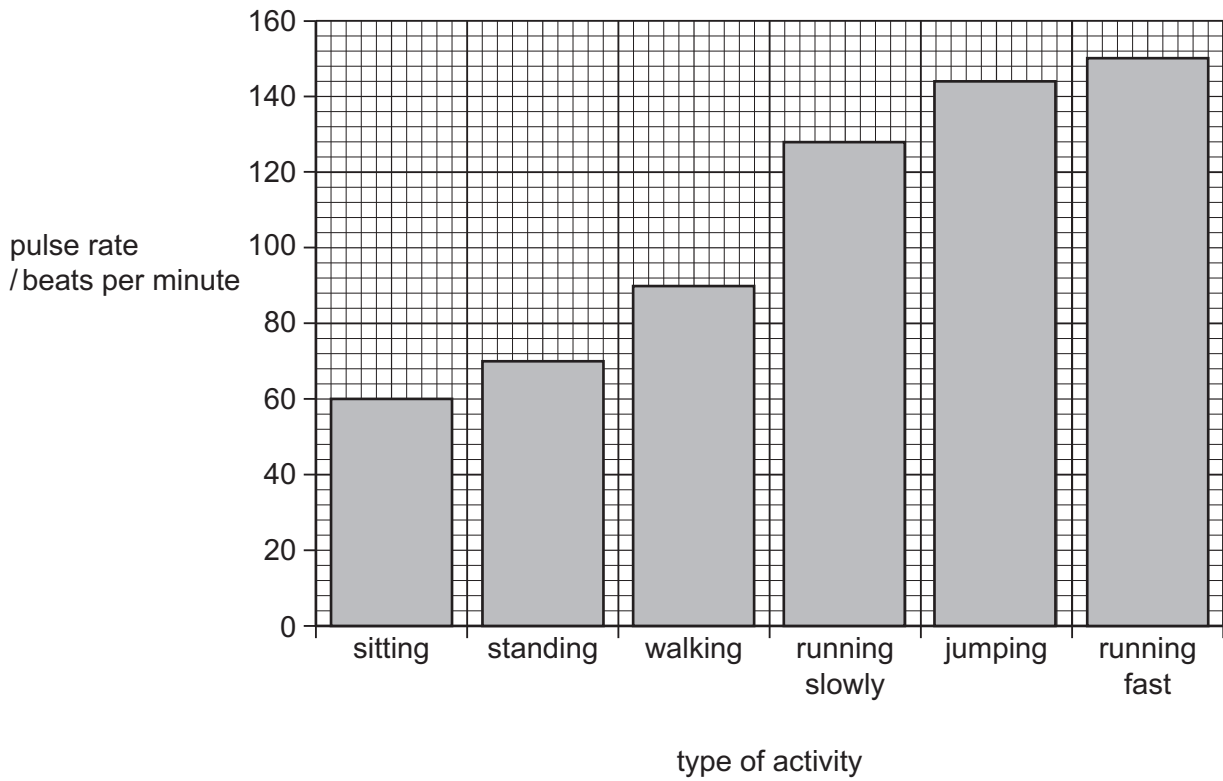

Fig. 1.2

(i) Place a tick (✓) in **one** box to show the activity that results in a pulse rate of between 120 and 140 beats per minute.

jumping	<input type="checkbox"/>	sitting	<input type="checkbox"/>
running fast	<input type="checkbox"/>	standing	<input type="checkbox"/>
running slowly	<input type="checkbox"/>	walking	<input type="checkbox"/>

[1]

(ii) Calculate the difference in pulse rate between sitting and running fast.

pulse rate sitting = beats per minute

pulse rate running fast = beats per minute

difference in pulse rate = beats per minute

[2]

(iii) Describe how the person's **breathing** is different when walking compared to jumping.

.....

.....

[2]

[Total: 12]

- 2 (a) The order of reactivity for some metals is shown in Fig. 2.1.

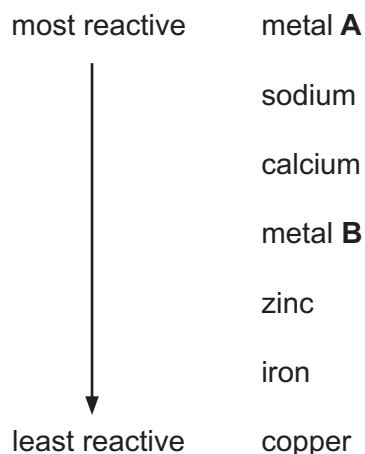

Fig. 2.1

- (i) Suggest the identities of metals **A** and **B**.

A

B

[1]

- (ii) State **two** observations for the reaction of sodium with water.

1

2

[2]

- (b) Sodium is in Group I of the Periodic Table.

Iron is a transition element.

Describe **two** physical properties of iron that show that it is different from sodium.

1

2

[2]

(c) Brass is an alloy of zinc and one other metal.

State the name of this other metal.

..... [1]

(d) Recycling metals uses less energy and costs less money than extracting the metals from their ores.

State **one** other reason why metals need to be recycled.

.....

..... [1]

(e) Sodium and chlorine react together in an exothermic reaction to form sodium chloride.

(i) State what is meant by *exothermic*.

.....
 [1]

(ii) Fig. 2.2 shows the electronic structures of a sodium **ion**, Na^+ , and a chloride **ion**, Cl^- , in sodium chloride.

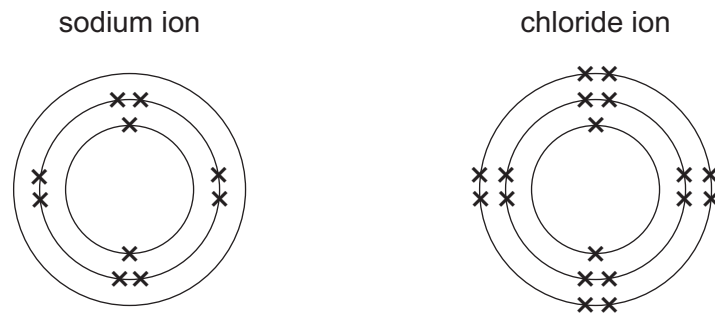

Fig. 2.2

Complete Fig. 2.3 to show the electronic structures of a sodium **atom**, Na , and a chlorine **atom**, Cl .

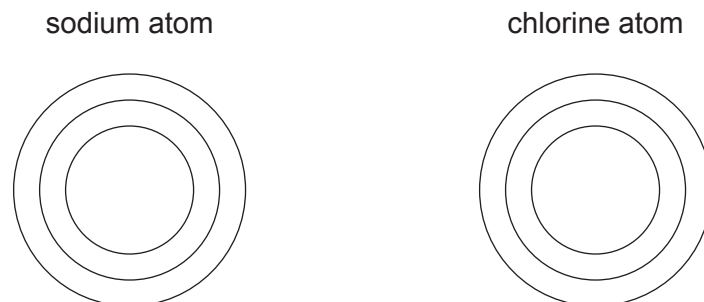

Fig. 2.3

[2]

[Total: 10]

3 (a) Fig. 3.1 shows a wave.

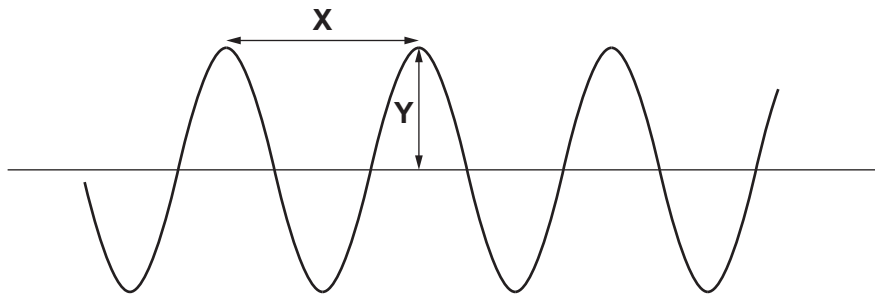

Fig. 3.1

Use Fig. 3.1 to complete the two sentences about the wave.

- X shows the of the wave.
- Y shows the of the wave.

[2]

(b) Table 3.1 shows the frequency ranges of sounds emitted by different species of whale.

Table 3.1

species	frequency range / Hz
beluga whale	40–60 000
blue whale	10–39
dwarf minke whale	50–9 400
fin whale	16–40

State which species of whale emits sounds that are **all** heard by a healthy human ear.

Give a reason for your answer.

species of whale

reason

.....

[2]

(c) A whale is swimming at a constant speed.

(i) State the size of the resultant force on the whale.

Give a reason for your answer.

resultant force = N

reason

.....

[1]

(ii) The whale swims at a constant speed of 6.1 m/s for 15 minutes.

Calculate the distance the whale travels in this time.

distance = m [3]

(iii) Energy is transferred while the whale is swimming.

Complete the boxes to show the energy transfers that take place.

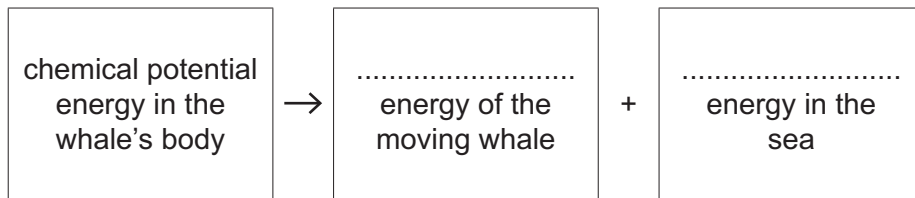

[2]

[Total: 10]

- 4 (a) Table 4.1 shows the names and functions of some organs associated with the alimentary canal.

Complete Table 4.1.

Table 4.1

organ	function
pancreas	produces enzymes used in the intestine for digestion
.....	produces bile which is stored in the gall bladder
salivary gland	makes saliva and releases it into the for digestion

[3]

- (b) Enzymes in saliva break down large starch molecules into smaller glucose molecules.

- (i) Glucose is a reducing sugar.

State the name of the test solution used to identify the presence of a reducing sugar in food.

..... [1]

- (ii) Circle the name of **one** other large molecule made from glucose molecules.

amino acids fatty acids glycerol glycogen

[1]

- (c) Food labels show the quantities of nutrients found in the food.

Fig. 4.2 shows a food label from a box of burgers.

Each grilled burger (94 g) contains

Energy	Fat	Saturated fat	Sugars	Salt
898 kJ	12 g	5.8 g	0.7 g	0.6 g

Fig. 4.2

- (i) A person eats **two** burgers.

Calculate the mass of salt the person eats.

..... g [1]

- (ii) The label does **not** show a value for fibre.

State the importance of eating fibre in a balanced diet.

.....
 [1]

[Total: 7]

- 5 (a) The boxes on the left of Fig. 5.1 show some separation and collection methods.

The boxes on the right of Fig. 5.1 show some substances and the mixtures they come from.

Complete Fig. 5.1 to show the method used to separate and collect each substance from its mixture.

Draw one line from each box on the left to one box on the right.

Distillation of water from salty water has been done as an example for you.

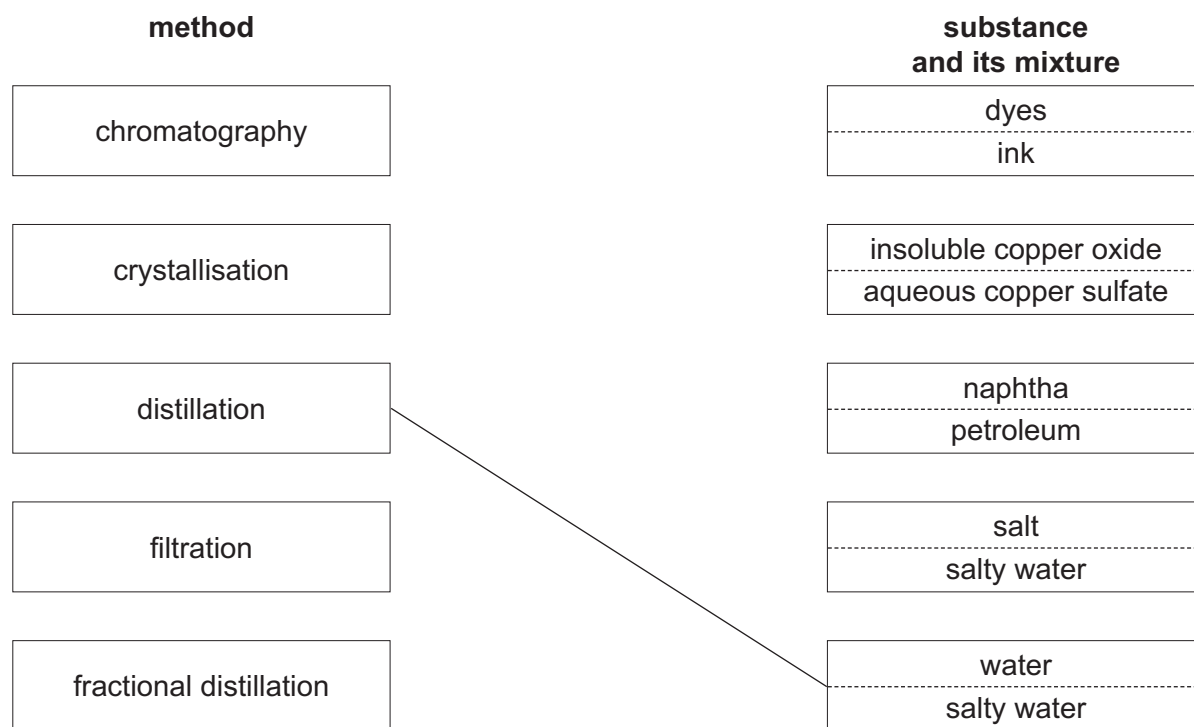

Fig. 5.1

[2]

(b) Evaporation is also used to separate some mixtures.

During evaporation, a liquid becomes a gas.

(i) Explain why evaporation is a physical change and **not** a chemical change.

.....
..... [1]

(ii) Describe how the structure of a gas is different to the structure of a liquid in terms of particle arrangement and particle motion.

particle arrangement

.....

particle motion

..... [2]

(c) Copper sulfate and water are made when copper oxide reacts with an acid.

State the name of this acid.

..... [1]

(d) State **one** use for naphtha.

..... [1]

[Total: 7]

- 6 Fig. 6.1 shows a gas flame being used to heat a metal kettle of water until the water boils.

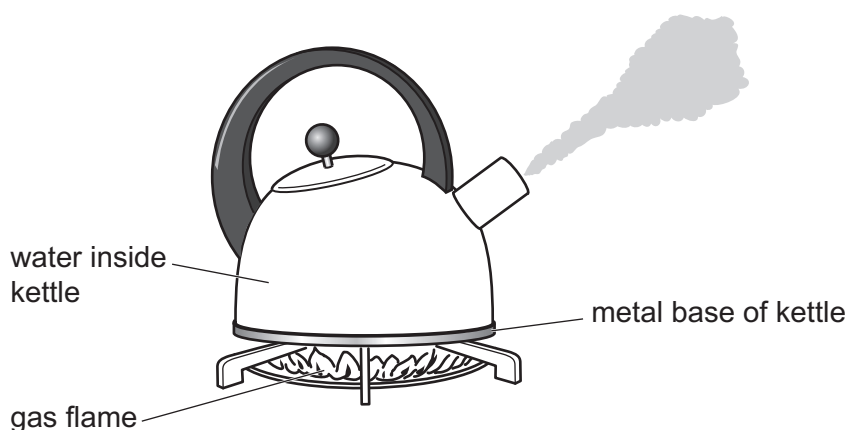

Fig. 6.1

- (a) (i) State the boiling point of water in degrees Celsius.

..... °C [1]

- (ii) Identify the main method of thermal energy transfer:

- through the metal base of the kettle
- through the water in the kettle

[2]

- (b) Natural gas is a non-renewable source of energy.

State two **renewable** sources of energy.

1

2

[2]

- (c) Fig. 6.2 shows a student standing in front of a plane mirror. The student is pouring water from the kettle into a cup.

There is an image of the student in the plane mirror.

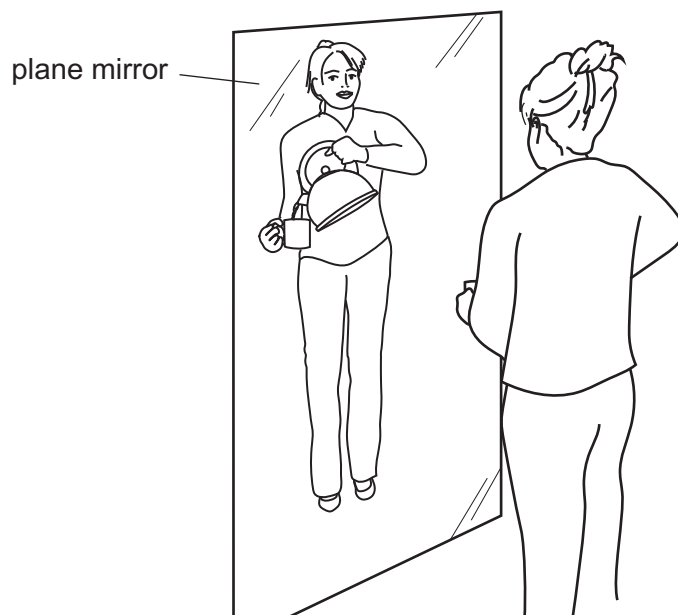

Fig. 6.2

The image of the student in the mirror is *laterally inverted*.

This lateral inversion is a *characteristic* of the image.

- (i) Describe how Fig. 6.2 shows that the image of the student is *laterally inverted*.

.....

 [2]

- (ii) State **one** other *characteristic* of the image in the mirror.

..... [1]

[Total: 8]

7 (a) Fig. 7.1 shows the life cycle of a plant.

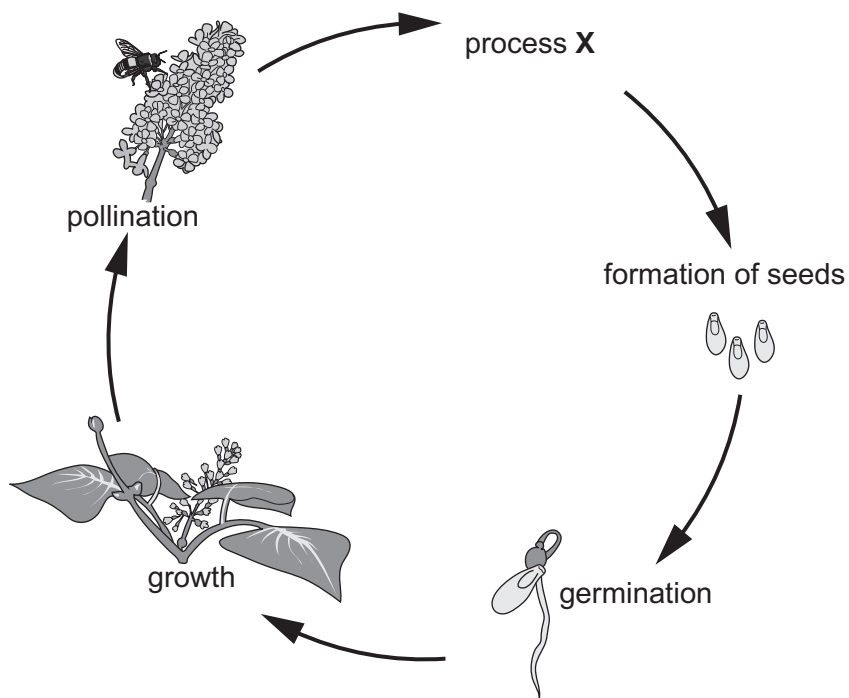

Fig. 7.1

(i) Identify process X in Fig. 7.1.

..... [1]

(ii) Explain why plants need amino acids for growth.

.....
.....
..... [2]

(b) Fig. 7.2 shows some of the parts of an insect-pollinated flower.

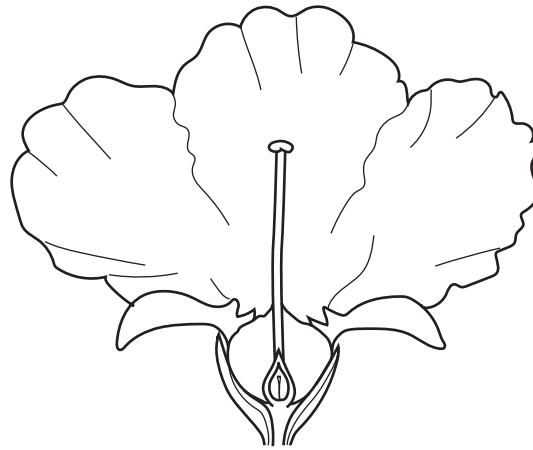

Fig. 7.2

(i) On Fig. 7.2, draw a label line and the letter **P** to show where pollination occurs. [1]

(ii) The male parts of the flower are **not** visible in Fig. 7.2.

State the name of **one** male part of the flower **not** visible in Fig. 7.2.

..... [1]

(c) Plants can also reproduce asexually.

Complete these sentences to define the term asexual reproduction.

Asexual reproduction is a process resulting in the production of

identical offspring from parent.

[2]

(d) The roots of a plant grow down into the ground in response to gravity.

State the name of this response.

..... [1]

[Total: 8]

8 Methane, CH_4 , is a hydrocarbon.

(a) State what is meant by *hydrocarbon*.

.....
 [2]

(b) Methane is an alkane. An alkane contains only single covalent bonds.

Fig. 8.1 is a dot-and-cross diagram of a molecule of methane, CH_4 . Only the outer shell electrons are shown.

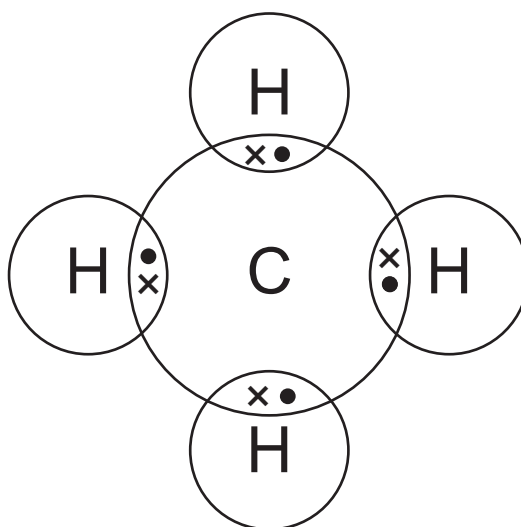

Fig. 8.1

Use Fig. 8.1 to describe what is meant by *single covalent bonds*.

.....

 [2]

(c) The complete combustion of methane produces carbon dioxide and water.

(i) Balance the equation for the complete combustion of methane.



(ii) State and explain whether the carbon in methane is oxidised or reduced in this reaction.

carbon

explanation

..... [1]

(iii) Explain why argon, a noble gas, does not react with oxygen.

Use ideas about electronic structure in your answer.

.....

..... [1]

(d) Describe how the bonding in alkenes is different from the bonding in alkanes.

.....

..... [1]

[Total: 9]

9 Fig. 9.1 shows three identical resistors, **E**, **F** and **G**, connected to a battery and an ammeter.

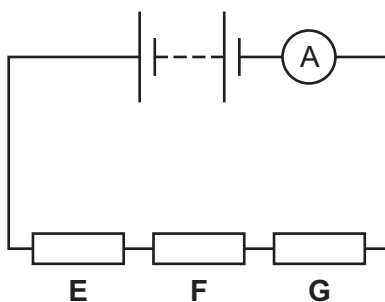

Fig. 9.1

(a) The resistors each have a resistance of $10\ \Omega$.

(i) Calculate the combined resistance of resistors **E**, **F** and **G** in this circuit.

resistance = Ω [1]

(ii) The ammeter reading is 0.12A .

Calculate the potential difference across the three resistors.

State the unit of your answer.

potential difference = unit [3]

(b) State the name of the circuit component with the electrical symbol shown.



..... [1]

- (c) Fig. 9.2 shows resistors **E**, **F** and **G** in a different circuit with three ammeters, **A₁**, **A₂**, and **A₃**, and a switch, **S**.

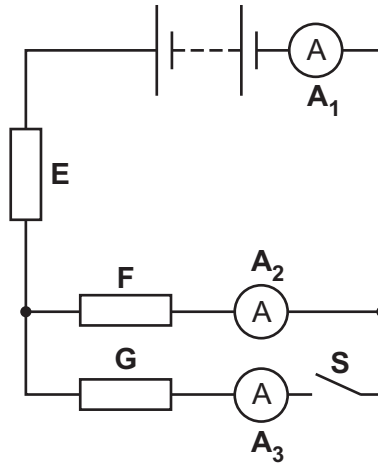

Fig. 9.2

- (i) State the type of circuit arrangement for resistors **F** and **G**.

..... [1]

- (ii) Switch **S** is closed.

State which ammeter, **A₁**, **A₂** or **A₃**, shows the highest reading.

Give a reason for your answer.

ammeter

reason

..... [1]

- (iii) Switch **S** is opened.

Describe how the reading on ammeter **A₂** compares with the reading on ammeter **A₁**.

Give a reason for your answer.

description

reason

..... [2]

[Total: 9]

BLANK PAGE

Permission to reproduce items where third-party owned material protected by copyright is included has been sought and cleared where possible. Every reasonable effort has been made by the publisher (UCLES) to trace copyright holders, but if any items requiring clearance have unwittingly been included, the publisher will be pleased to make amends at the earliest possible opportunity.

To avoid the issue of disclosure of answer-related information to candidates, all copyright acknowledgements are reproduced online in the Cambridge Assessment International Education Copyright Acknowledgements Booklet. This is produced for each series of examinations and is freely available to download at www.cambridgeinternational.org after the live examination series.

Cambridge Assessment International Education is part of the Cambridge Assessment Group. Cambridge Assessment is the brand name of the University of Cambridge Local Examinations Syndicate (UCLES), which itself is a department of the University of Cambridge.

The Periodic Table of Elements

Group																		
I	II	III										IV	V	VI	VII	VIII		
3 Li lithium 7	4 Be beryllium 9	<div style="text-align: center;"> Key atomic number atomic symbol name relative atomic mass </div>										6 C carbon 12	7 N nitrogen 14	8 O oxygen 16	9 F fluorine 19	10 Ne neon 20		
11 Na sodium 23	12 Mg magnesium 24	13 Al aluminium 27	14 Si silicon 28	15 P phosphorus 31	16 S sulfur 32	17 Cl chlorine 35.5	18 Ar argon 40											36 Kr krypton 84
19 K potassium 39	20 Ca calcium 40	21 Sc scandium 45	22 Ti titanium 48	23 V vanadium 51	24 Cr chromium 52	25 Mn manganese 55	26 Fe iron 56	27 Co cobalt 59	28 Ni nickel 59	29 Cu copper 64	30 Zn zinc 65	31 Ga gallium 70	32 Ge germanium 73	33 As arsenic 75	34 Se selenium 79	35 Br bromine 80	36 Kr krypton 84	
37 Rb rubidium 85	38 Sr strontium 88	39 Y yttrium 89	40 Zr zirconium 91	41 Nb niobium 93	42 Mo molybdenum 96	43 Tc technetium —	44 Ru ruthenium 101	45 Rh rhodium 103	46 Pd palladium 106	47 Ag silver 108	48 Cd cadmium 112	49 In indium 115	50 Sn tin 119	51 Sb antimony 122	52 Te tellurium 128	53 I iodine 127	54 Xe xenon 131	
55 Cs caesium 133	56 Ba barium 137	57–71 lanthanoids	72 Hf hafnium 178	73 Ta tantalum 181	74 W tungsten 184	75 Re rhenium 186	76 Os osmium 190	77 Ir iridium 192	78 Pt platinum 195	79 Au gold 197	80 Hg mercury 201	81 Tl thallium 204	82 Pb lead 207	83 Bi bismuth 209	84 Po polonium —	85 At astatine —	86 Rn radon —	
87 Fr francium —	88 Ra radium —	89–103 actinoids	104 Rf rutherfordium —	105 Db dubnium —	106 Sg seaborgium —	107 Bh bohrium —	108 Hs hassium —	109 Mt meitnerium —	110 Ds darmstadtium —	111 Rg roentgenium —	112 Cn copernicium —	114 Fl flerovium —	116 Lv livermorium —				—	

lanthanoids	57 La lanthanum 139	58 Ce cerium 140	59 Pr praseodymium 141	60 Nd neodymium 144	61 Pm promethium —	62 Sm samarium 150	63 Eu europium 152	64 Gd gadolinium 157	65 Tb terbium 159	66 Dy dysprosium 163	67 Ho holmium 165	68 Er erbium 167	69 Tm thulium 169	70 Yb ytterbium 173	71 Lu lutetium 175
actinoids	89 Ac actinium —	90 Th thorium 232	91 Pa protactinium 231	92 U uranium 238	93 Np neptunium —	94 Pu plutonium —	95 Am americium —	96 Cm curium —	97 Bk berkelium —	98 Cf californium —	99 Es einsteinium —	100 Fm fermium —	101 Md mendelevium —	102 No nobelium —	103 Lr lawrencium —

The volume of one mole of any gas is 24 dm³ at room temperature and pressure (r.t.p.).