



Cambridge IGCSE™

CANDIDATE
NAME

CENTRE
NUMBER

--	--	--	--	--

CANDIDATE
NUMBER

--	--	--	--



COMBINED SCIENCE

0653/62

Paper 6 Alternative to Practical

May/June 2022

1 hour

You must answer on the question paper.

No additional materials are needed.

INSTRUCTIONS

- Answer **all** questions.
- Use a black or dark blue pen. You may use an HB pencil for any diagrams or graphs.
- Write your name, centre number and candidate number in the boxes at the top of the page.
- Write your answer to each question in the space provided.
- Do **not** use an erasable pen or correction fluid.
- Do **not** write on any bar codes.
- You may use a calculator.
- You should show all your working and use appropriate units.

INFORMATION

- The total mark for this paper is 40.
- The number of marks for each question or part question is shown in brackets [].

This document has **16** pages. Any blank pages are indicated.

- 1 (a) Water moves into a cell by osmosis.

A student investigates the effect of temperature on the movement of water by osmosis.

A dialysis tubing bag is used as a model cell.

Procedure

The student:

Step 1 Puts 10 cm^3 of glucose solution into each of two dialysis tubing bags.

Step 2 Ties a knot in the end of each bag, as shown in Fig. 1.1.

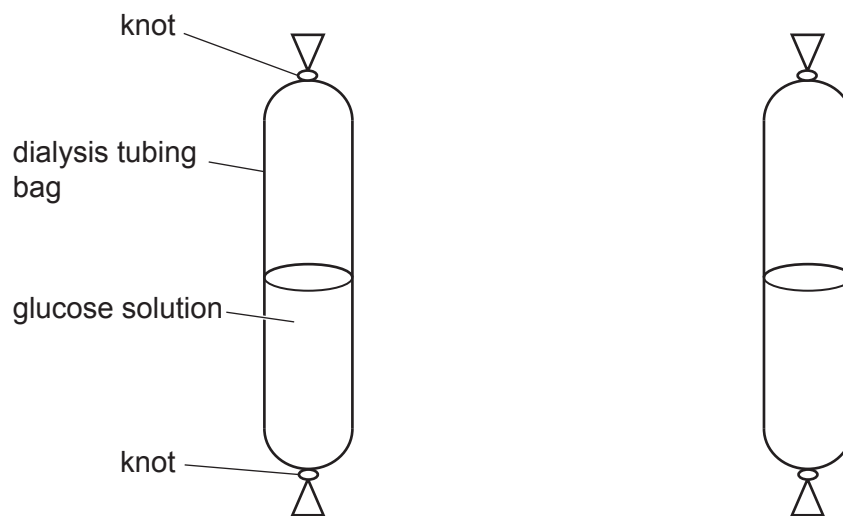

Fig. 1.1

Step 3 Records in Table 1.1 the **initial** mass of each dialysis tubing bag.

Step 4 Puts one dialysis tubing bag into a beaker of **cold** water, as shown in Fig. 1.2.

Step 5 Puts the other dialysis tubing bag into a beaker of **hot** water, as shown in Fig. 1.2.

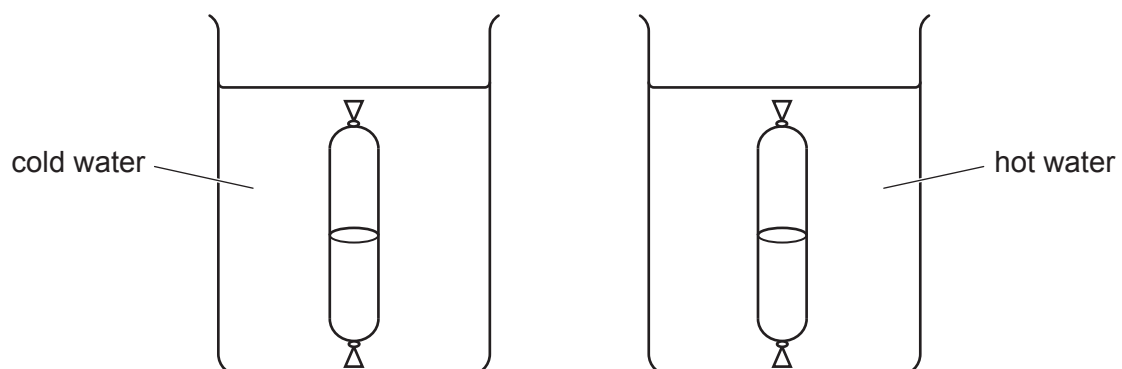

Fig. 1.2

Step 6 After 10 minutes, removes both dialysis tubing bags from the beakers and dries them with paper towels.

Step 7 Measures the **final** mass of each dialysis tubing bag.

- (i) Fig. 1.3 shows the readings on the balances for the two dialysis tubing bags in **Step 7**.

dialysis tubing bag from **cold** water

dialysis tubing bag from **hot** water



Fig. 1.3

Record in Table 1.1 the **final** mass of each dialysis tubing bag to **one** decimal place. [2]

Table 1.1

dialysis tubing bag	initial mass /g	final mass /g	change in mass /g
cold	10.9		
hot	11.3		

- (ii) Calculate the **change in mass** for each dialysis tubing bag. Record your answers in Table 1.1. [1]
- (iii) Describe the effect of temperature on the mass of water entering the dialysis tubing bags.

.....
 [1]

- (iv) Explain why the dialysis tubing bags are dried before measuring the **final** mass.

.....
 [1]

- (v) The student thinks that the reducing sugar glucose may have leaked out of one of the bags.

State the reagent used to test for the presence of glucose.

..... [1]

- (b) Fig. 1.4 shows a photograph of a slice of lemon (a citrus fruit). The slice of lemon has an inner flesh part and an outer skin part.

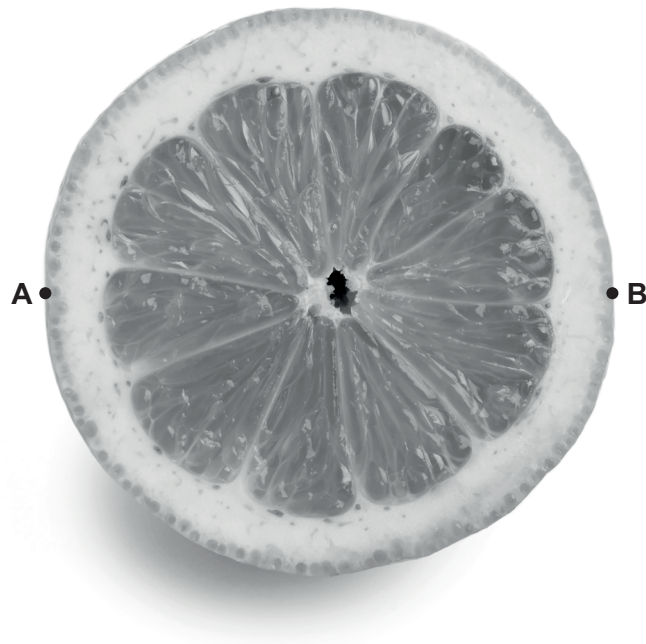

Fig. 1.4

- (i) In the box provided, make a large, clear pencil drawing of the slice of lemon.

- (ii) Draw a line to join points **A** and **B** on Fig. 1.4.

Record the length **AB** in millimetres to the nearest millimetre.

length of line **AB** on Fig. 1.4 = mm [1]

- (iii) Draw line **AB** on your drawing in (b)(i).

Record the length **AB** of your drawing, in millimetres to the nearest millimetre.

length of line **AB** on your drawing = mm [1]

- (iv) Calculate the magnification of your drawing.

Use the equation shown.

$$\text{magnification} = \frac{\text{length of line AB on your drawing}}{\text{length of line AB on Fig. 1.4}}$$

magnification = [1]

- (v) Iodine solution is added to the slice of lemon. The inner flesh part stains brown and the outer skin part stains blue-black.

State a conclusion for these results.

.....
 [1]

[Total: 13]

2 A student investigates the solubility in water of some substances, **L**, **M**, **N**, **P** and **Q**.

(a) **Procedure**

The student:

- adds solid **L** to water
- stirs the mixture of **L** and water
- records their observations in Table 2.1.

The student repeats the procedure with solids **M**, **N** and **P**.

Table 2.1

solid	observations
L	dissolves and makes a colourless solution
M	does not dissolve and stays white
N	dissolves and makes a blue solution
P	green solid in a colourless liquid

(i) State which solids, **L**, **M**, **N** or **P** are insoluble in water.

..... [1]

(ii) A mixture of **M** and water is separated using filtration.

Draw a labelled diagram of the assembled apparatus used to separate this mixture.

Include labels for the filtrate and residue.

[3]

(iii) The blue solution formed from solid **N** contains copper(II) ions.

The student adds aqueous sodium hydroxide to this solution.

Describe the observations.

..... [1]

(b) Procedure

The student:

Step 1 Adds a sample of solid **Q** to 10.0 cm³ of distilled water in a test-tube.

Step 2 Places the test-tube into a hot water-bath and stirs the mixture until all of **Q** dissolves.

Step 3 Places the test-tube with the hot solution into a beaker of cold water to cool the solution.

Step 4 Records the temperature when the first crystals of **Q** appear in the test-tube.

The temperature when the first crystals appear is 45.0 °C.

(i) Name a piece of apparatus suitable to measure the 10.0 cm³ of distilled water in **Step 1**.

..... [1]

(ii) A student repeats the procedure in (b) but in **Step 3** cools the test-tube with the hot solution in **air** instead of in cold water.

Suggest why cooling the solution in air will give a more accurate temperature for when the first crystals appear.

.....

..... [1]

- (c) A student repeats the procedure in (b) using different masses of **Q**. The results are shown in Table 2.2.

Table 2.2

mass of Q in solution /g	temperature when first crystals of Q appear /°C
5	8
10	30
15	50
20	65
25	75

- (i) On the grid, plot a graph of the temperature when first crystals of **Q** appear (vertical axis) against the mass of **Q** in solution.

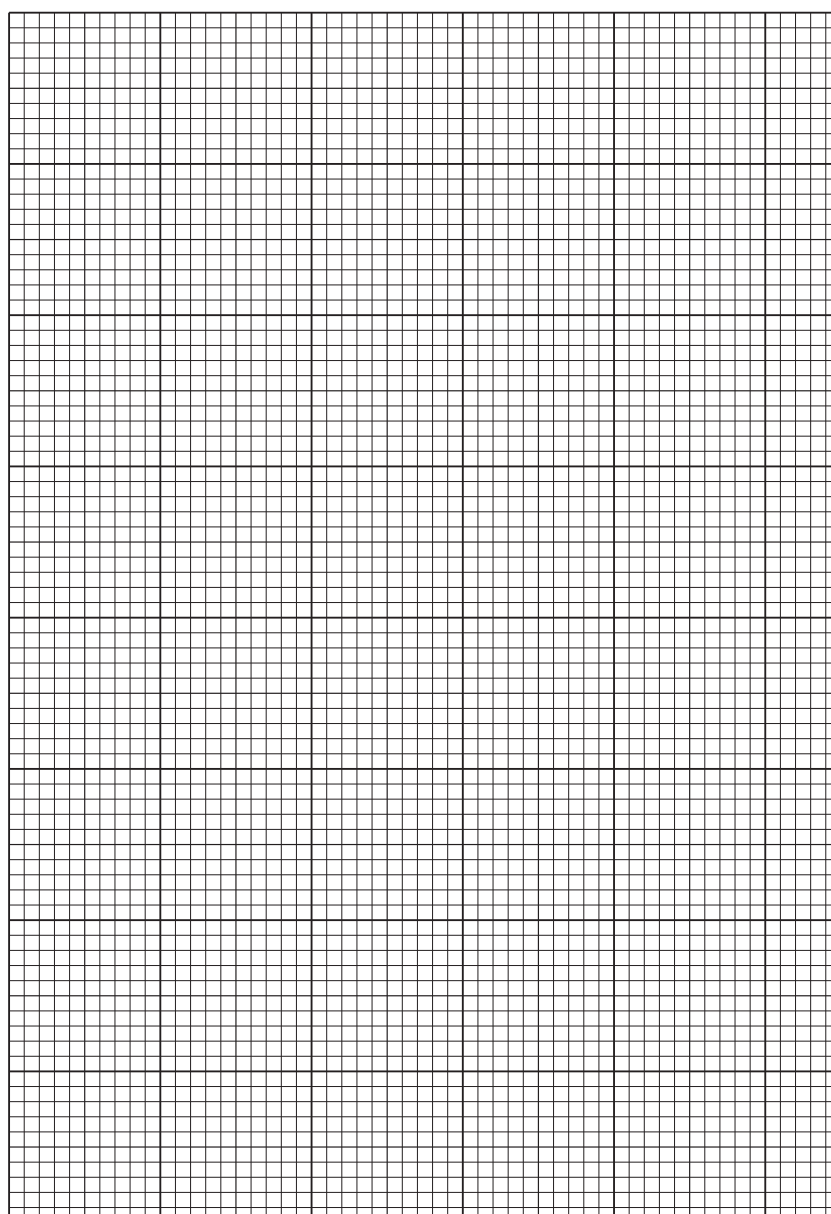

- (ii) Draw the curve of best-fit. [1]
- (iii) Describe the relationship between the mass of **Q** in the solution and the temperature when the first crystals appear.
-
- [1]
- (iv) Use the temperature in (b) and your graph to estimate the mass of **Q** used in the procedure in (b).

mass of **Q** = g [1]

[Total: 13]

3 A student investigates thermal energy changes in water.

(a) Procedure

The student:

- measures the temperature of 50 cm^3 of hot water
- measures the temperature of 150 cm^3 of water at room temperature
- pours the hot water into the water at room temperature as shown in Fig. 3.1
- stirs the mixture of water
- measures the final temperature of the mixture.

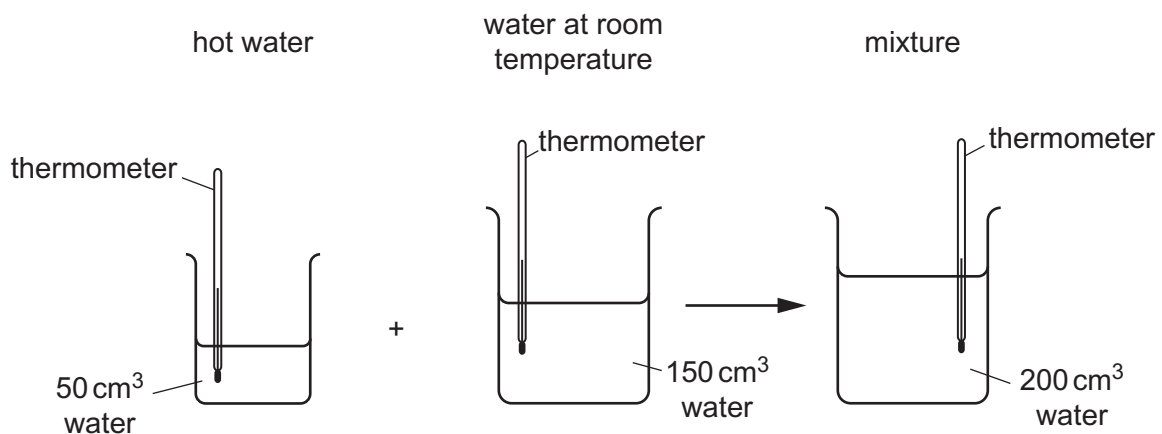

Fig. 3.1

Fig. 3.2 shows the readings on the thermometer in the hot water and the thermometer in the water at room temperature.

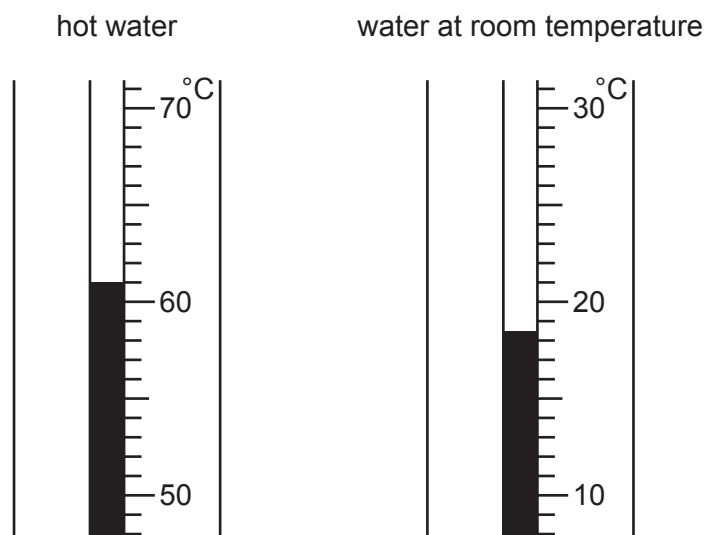

Fig. 3.2

Record the temperature readings, to the nearest 0.5°C, in Table 3.1.

Table 3.1

	volume of water /cm ³	temperature /°C
hot water	50	
water at room temperature	150	
mixture	200	28.0

[2]

(b) Explain why it is important to stir the mixture before taking the final temperature reading.

.....
 [1]

(c) (i) Calculate,

- the difference in temperature between the water at room temperature and the final mixture, ΔT_R
- the difference in temperature between the hot water and the final mixture, ΔT_H .

Record your answers in Table 3.2.

Table 3.2

$\Delta T_R / ^\circ\text{C}$	$\Delta T_H / ^\circ\text{C}$

[1]

(ii) Calculate the increase in thermal energy ΔE_R of the water at room temperature.

Use the equation shown.

$$\Delta E_R = 630 \times \Delta T_R$$

$$\Delta E_R = \dots\dots\dots \text{ J [1]}$$

(iii) Calculate the decrease in thermal energy ΔE_H of the hot water.

Use the equation shown.

Give your answer to **two** significant figures.

$$\Delta E_H = 210 \times \Delta T_H$$

$$\Delta E_H = \dots\dots\dots \text{ J [1]}$$

- (d) A student suggests that the increase in thermal energy ΔE_R of the water at room temperature should be equal to the decrease in thermal energy ΔE_H of the hot water.

Suggest **one** reason why your answers to (c)(ii) and (c)(iii) are **not** equal.

.....

..... [1]

[Total: 7]

- 4 Fig. 4.1 shows a door, hinged at one side. The door can be pulled open by applying a force to the metal ring at any point along the bar **AB**.

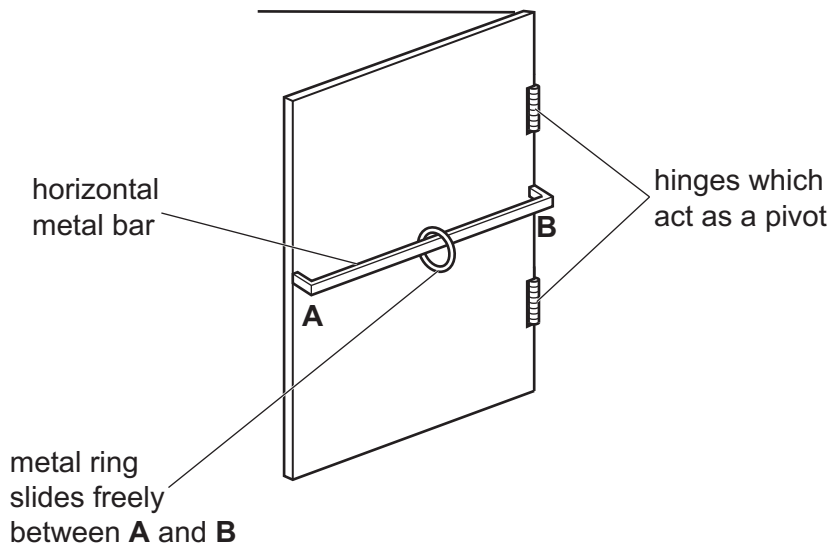

Fig. 4.1

Plan an investigation to find out how the size of the force needed to just open the door varies with the distance of the force away from **B**.

You are given the apparatus in Fig. 4.1 and you may use any common laboratory apparatus.

In your plan include:

- the apparatus needed
- a brief description of the method and an explanation of any safety precautions you will take
- what you will measure and the variables you will control
- a results table to record the measurements
- how you will process your results to draw a conclusion.

You are not required to include any results in your results table.

You may include a labelled diagram if you wish.

BLANK PAGE

Permission to reproduce items where third-party owned material protected by copyright is included has been sought and cleared where possible. Every reasonable effort has been made by the publisher (UCLES) to trace copyright holders, but if any items requiring clearance have unwittingly been included, the publisher will be pleased to make amends at the earliest possible opportunity.

To avoid the issue of disclosure of answer-related information to candidates, all copyright acknowledgements are reproduced online in the Cambridge Assessment International Education Copyright Acknowledgements Booklet. This is produced for each series of examinations and is freely available to download at www.cambridgeinternational.org after the live examination series.

Cambridge Assessment International Education is part of Cambridge Assessment. Cambridge Assessment is the brand name of the University of Cambridge Local Examinations Syndicate (UCLES), which is a department of the University of Cambridge.